

SCALE 1:30

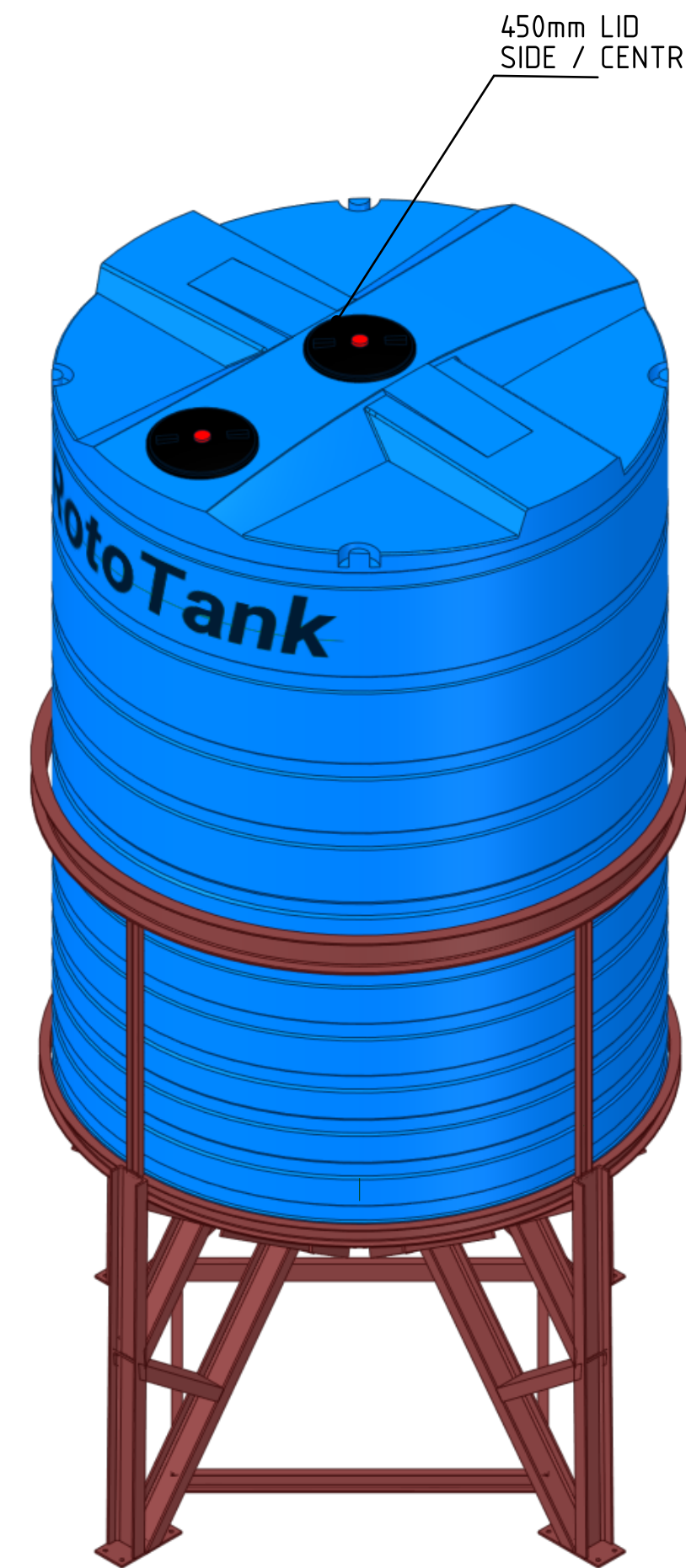

SCALE 1:30

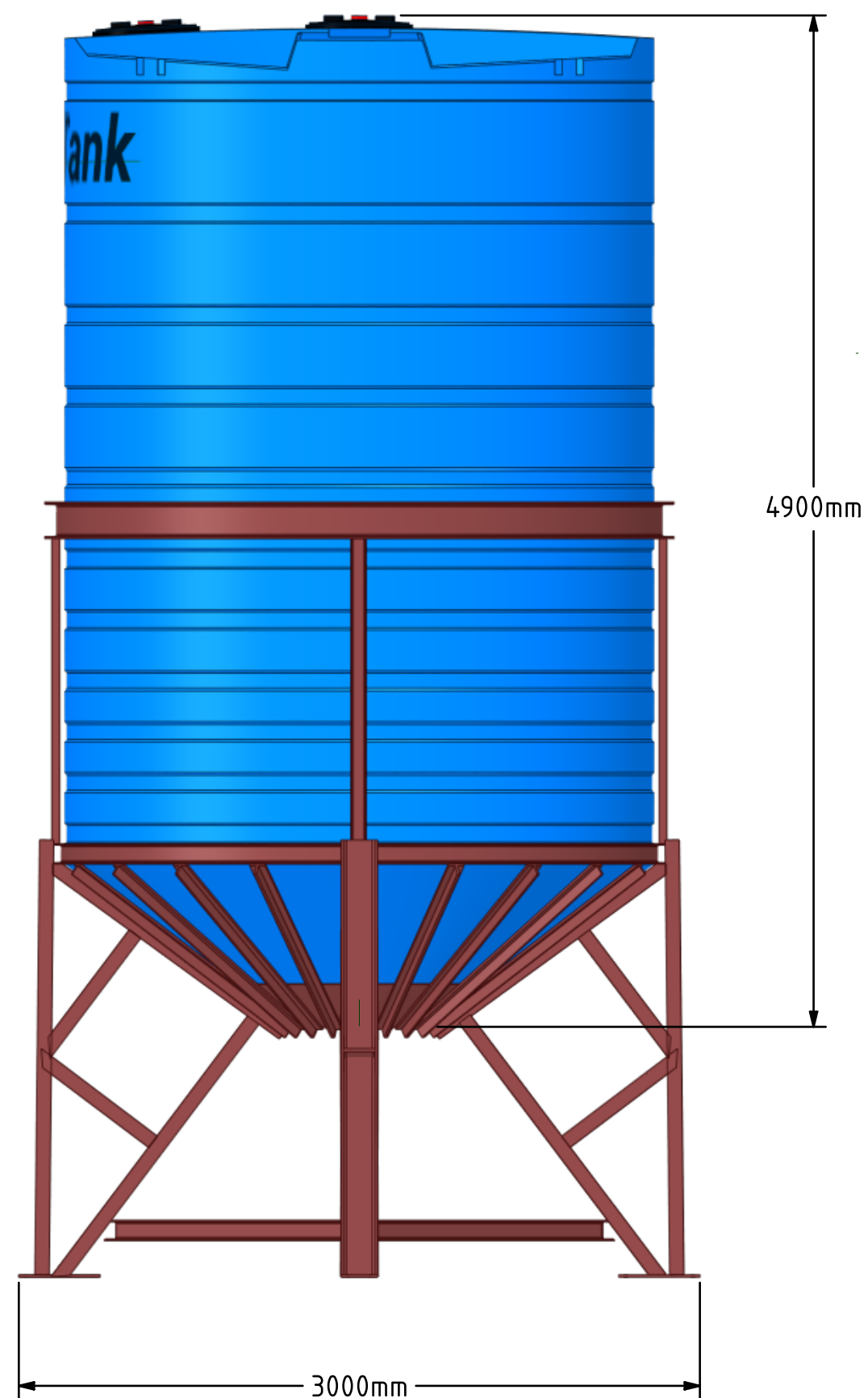
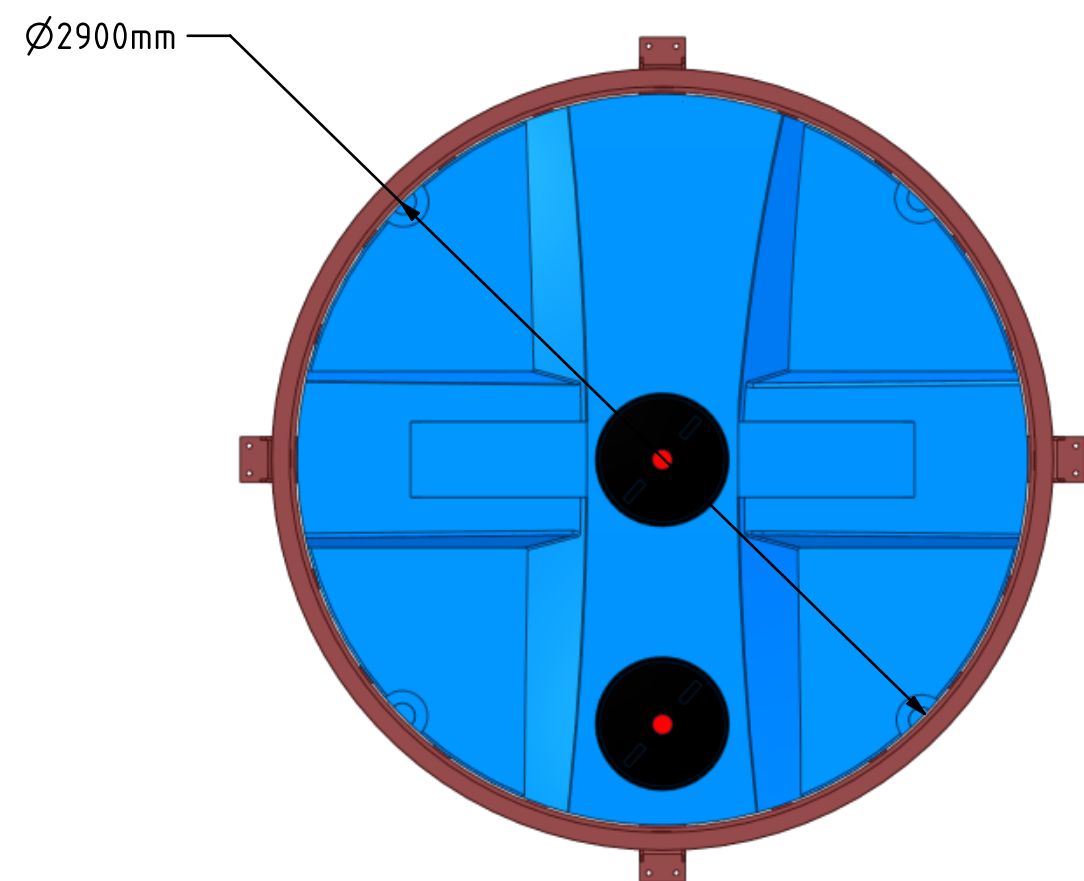

NOTES:  
SIZES INDICATED IN THIS DRAWING ARE SUBJECT TO MATERIAL SHRINK VARIATIONS AND MAY VARY WITH APPROXIMATELY 3%.

Date	Name
DRAWN	
CHECKED	
ENG. APPR.	
MFG APPR.	

TITLE: SILOS FOR LIQUID AND BULK STORAGE



PROPRIETARY AND CONFIDENTIAL  
THE INFORMATION CONTAINED IN THIS DRAWING IS  
THE SOLE PROPERTY OF ROTOTANK. ANY  
REPRODUCTION IN PART OR AS A WHOLE WITHOUT  
THE WRITTEN PERMISSION OF ROTOTANK IS  
PROHIBITED.

DWG No.

**S27000L & STAND**

SHEET

1