

SCALE 1:10

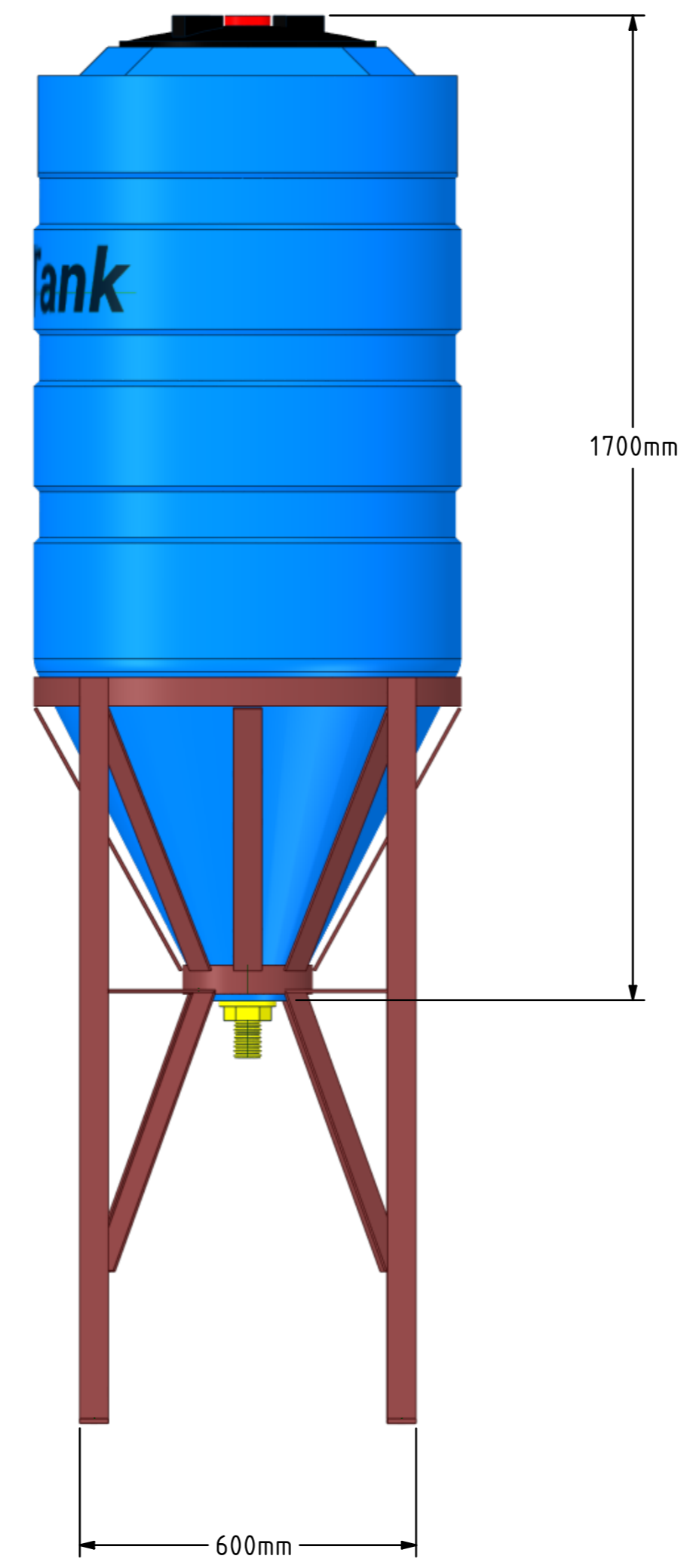

SCALE 1:10

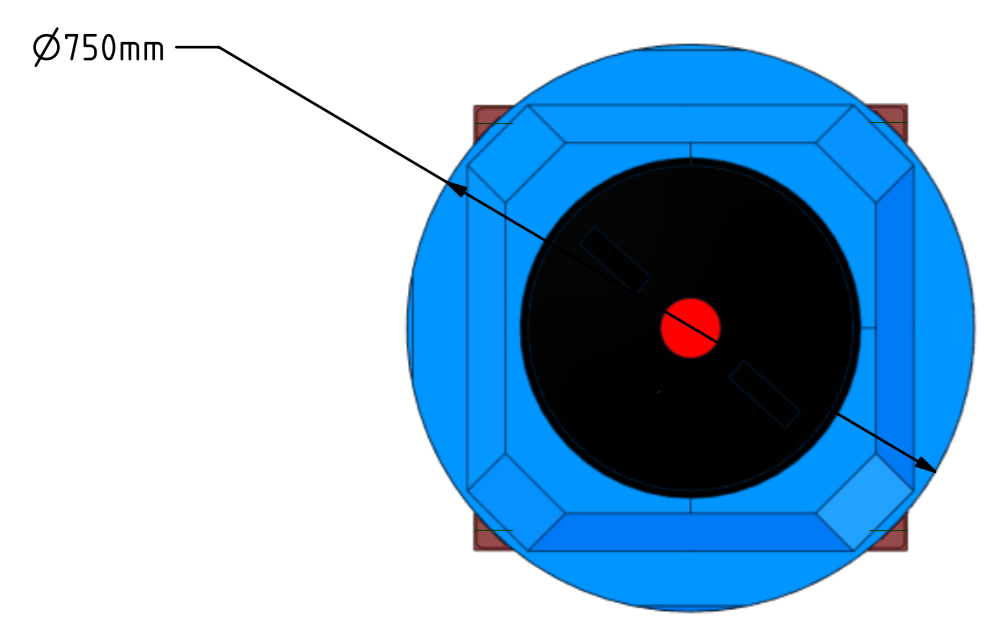

NOTES:
SIZES INDICATED IN THIS DRAWING ARE SUBJECT TO MATERIAL SHRINK VARIATIONS AND MAY VARY WITH APPROXIMATELY 3%.

Date	Name
DRAWN	
CHECKED	
ENG. APPR.	
MEG APPR.	

TITLE: SILOS FOR LIQUID AND BULK STORAGE



PROPRIETARY AND CONFIDENTIAL
THE INFORMATION CONTAINED IN THIS DRAWING IS
THE SOLE PROPERTY OF ROTOTANK. ANY
REPRODUCTION IN PART OR AS A WHOLE WITHOUT
THE WRITTEN PERMISSION OF ROTOTANK IS
PROHIBITED.

DWG No.
S750L & STAND
SHEET 1